

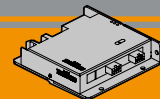

Azionamenti per motori CC DC motor controls





	Indice	Index	Pag. Page
PLN19-8	Schema dei collegamenti	<i>Main connection diagram</i>	R2
	Caratteristiche tecniche	<i>Technical features</i>	R2
	Dimensioni	<i>Dimensions</i>	R3
	Opzioni	<i>Options</i>	R3
PLN20 PLN40	Schema dei collegamenti	<i>Main connection diagram</i>	R4
	Caratteristiche tecniche	<i>Technical features</i>	R5
	Dotazioni	<i>Equipment</i>	R5
	Manuale	<i>User manual</i>	R5
	Dimensioni	<i>Dimensions</i>	R6
	GUIDA alla selezione dell'azionamento	<i>Drive selection GUIDE</i>	R7
	Note	<i>Note</i>	R8

Questa sezione annulla e sostituisce ogni precedente edizione o revisione. Qualora questa sezione non Vi sia giunta in distribuzione controllata, l'aggiornamento dei dati ivi contenuto non è assicurato. **In tal caso la versione più aggiornata è disponibile sul nostro sito internet www.transtecno.com**

This section replaces any previous edition and revision. If you obtained this catalogue other than through controlled distribution channels, the most up to date content is not guaranteed. In this case the latest version is available on our web site www.transtecno.com

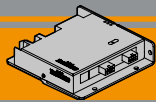

**AZIONAMENTO UNIDIREZIONALE PWM PER LA
REGOLAZIONE DI VELOCITA' DEI MOTORI A
CORRENTE CONTINUA A BASSA TENSIONE**

**LOW VOLTAGE SINGLE DIRECTION
PWM DC MOTORS CONTROL**

SCHEMA DEI COLLEGAMENTI - MAIN CONNECTION DIAGRAM

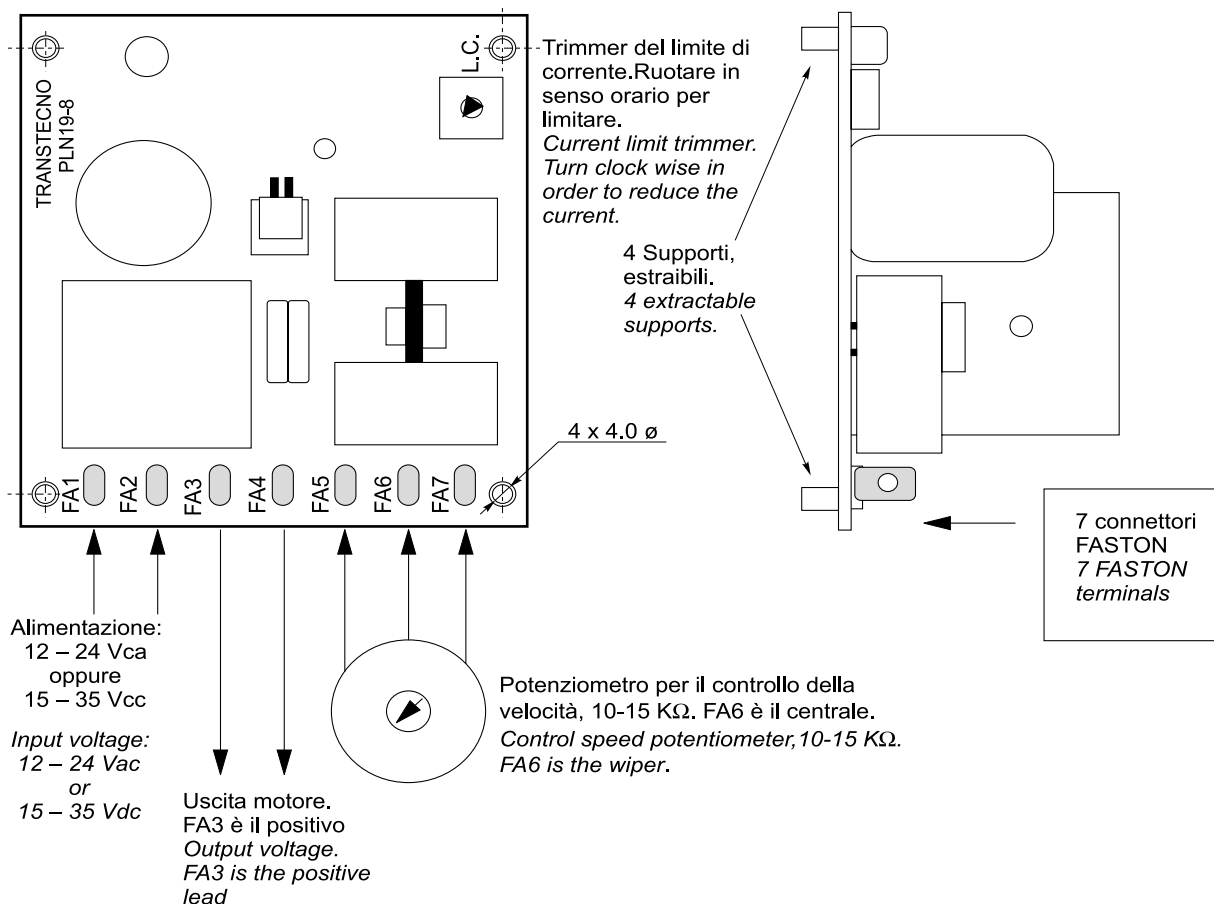

Attenzione: se si scollega il potenziometro con la scheda alimentata, il motore ruota alla velocità nominale.

Warning: if speed pot is disconnected when the board is powered, the motor runs at its maximum speed.

Caratteristiche tecniche

Technical features

- Alimentazione ai terminali FA1 e FA2:
12 - 24 Vca oppure 15 - 35 Vcc.
- Regolazione della velocità mediante potenziometro 10-15 KΩ.
- Trimmer di Limitazione della corrente, per adattare la scheda anche a motori di piccole potenze. Per limitare l'erogazione di corrente, ruotare in senso orario il trimmer.
- Uscita motore ai terminali FA3 e FA4, regolabile da 0 a Vcc MAX che è proporzionale alla tensione di ingresso. Con 35 Vcc di alimentazione, l'uscita MAX è circa 30 Vcc.
- Corrente di uscita (*): Massima corrente ammessa: 8 A in ambiente ventilato, servizio continuo.
- Peso: 0.120 Kg.
- Line voltage at terminals FA1 and FA2:
12 – 24 Vac or 15 – 35 Vdc.
- The speed of the drive is to be controlled by potentiometer, 10-15 KΩ.
- Current Limit trimmer, in order to suit the board for small motors. In order to limit the current, turn clock wise the trimmer.
- Output voltage from terminals FA3 and FA4, from 0 up to Vdc MAX which is proportional to the input voltage. With 35 Vdc input voltage, the max output voltage is about 30 Vdc.
- Output current (*): Maximum output current allowed: 8 A in a ventilated environment, continuous duty.
- Weight: 0.120 Kg.

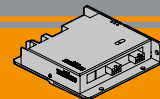

Dimensioni

Dimensions

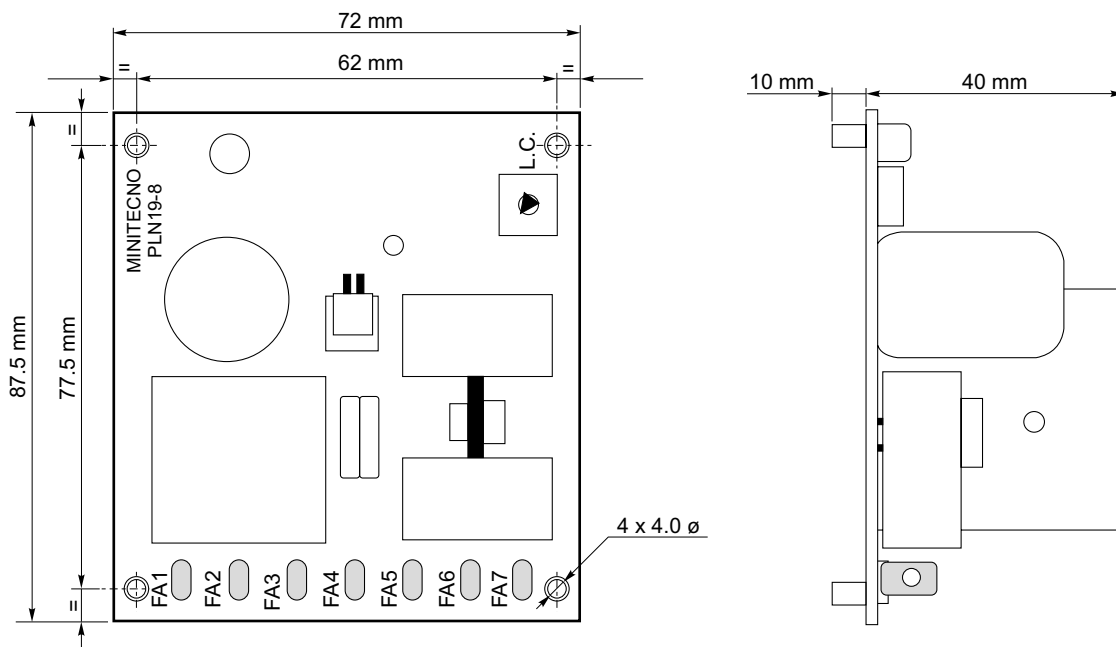

Opzioni

Options

1. Potenzimetro 10 kΩ
2. Supporto per montaggio su guida DIN

1. Speed potentiometer 10 kΩ
2. DIN mounting support

(*) il valore massimo di corrente motore deve essere utilizzato in **ambiente ventilato**. In ambienti non ventilati e per temperatura ambiente di 45 °C, ridurre la corrente motore massima a 4 A; servizio continuo.

(*) *the maximum output current value must be used in a ventilated environment. Derate the maximum output current down to 4 A if the environment is not ventilated and the temperature is about 45 °C; continuous duty.*

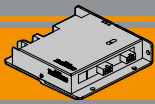

**AZIONAMENTO BIDIREZIONALE PWM PER LA
REGOLAZIONE DI VELOCITA' DEI MOTORI A
CORRENTE CONTINUA A BASSA TENSIONE**

**LOW VOLTAGE BIDIRECTIONAL
PWM DC MOTORS CONTROL**

SCHEMA DEI COLLEGAMENTI - MAIN CONNECTION DIAGRAM

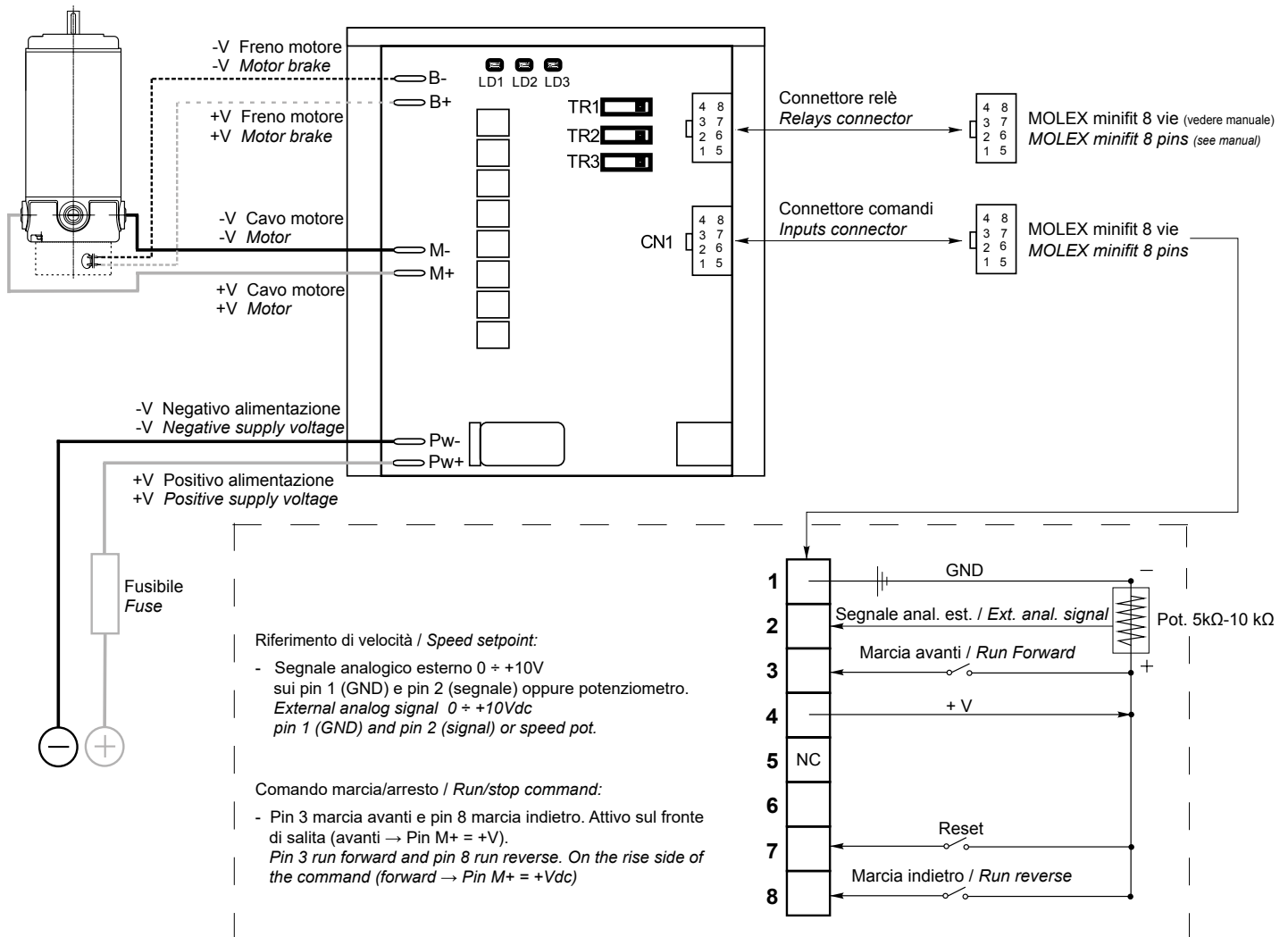

Fusibile:

150-200% della corrente motore. Max 3 volte la corrente nominale della scheda, con intervento entro pochi secondi.

Fuse:

150-200 % rated motor current. Max 3 times rated current of the drive (trip time in few seconds).

Trimmer multigiro:

TR1: Accelerazione: selezione da 0.5 a 10 sec.

TR2: Limite di corrente: riduce il limite di corrente nominale da 100% a circa 30% (corrente di picco 3 volte la corrente selezionata).

TR3: Decelerazione: selezione da 0.5 a 10 sec.

Multiturn trimmers:

TR1: Acceleration time: from 0.5 to 10 sec.

TR2: Current limitation: rated current limited from 100% to about 30% (peak current 3 times the selected limited current).

TR3: Deceleration time: from 0.5 to 10 sec.

LED:

LD1: Visualizza lo stato di funzionamento con limite di corrente attivo (il motore assorbe più della corrente selezionata e l'azionamento opera in limitazione).

LD2: Stato dell'azionamento: lampeggio veloce e continuo = funzionamento normale, lampeggio lento e codificato = presenza di un allarme

LD3: Segnalazione presenza alimentazione.

LED:

LD1: ON when the drive runs under current limitation (motor requires more than the rated current and drive supplies only limited current).

LD2: Status: quick continuous flash = drive ok, slow coded flash = fault).

LD3: Power ON

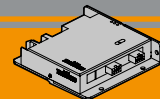

Caratteristiche tecniche

Technical features

- Scheda bidirezionale a transistor a ricircolo di corrente.
 - Selezionabili i seguenti parametri (mediante trimmer):
 - rampa di accelerazione: 0.5 - 10 sec
 - rampa di decelerazione: 0.5 - 10 sec
 - limite corrente 100%-30% circa
 - Temperatura di lavoro: 0°C / +40°C (allarme sotto zero)
 - Diagnostica tramite LED
 - Frequenza di commutazione: 16kHz
 - Dotata di coperchio
 - Velocità regolabile con potenziometro 5-10 kΩ o con segnale 0-10 Vcc
 - Limitazione della corrente regolabile
 - Sensore termico di protezione
- *Transistor bidirectional drive with regenerative current system.*
 - *Following settings can be adjusted (by built in trimmers):*
 - *acceleration ramp: 0.5 - 10 sec*
 - *deceleration ramp: 0.5 - 10 sec*
 - *current limit 100% - about 30%*
 - *Room temperature: 0°C / +40°C (alarm below zero)*
 - *LED for system diagnosis*
 - *Switching frequency: 16kHz*
 - *Covered*
 - *5-10 kΩ Speed pot. or 0-10 Vdc external signal for speed re-
gulation*
 - *Variable current limit*
 - *Thermal sensor for protection*

Modello Model number	Tensione di alimentazione DC input voltage [Vdc]	Tensione di uscita Motor voltage [Vdc]*	Corrente di uscita nominale DC load current [A]	Corrente di picco motore Maximum load current [A]**	Campo di alimentazione Power supply range [Vdc]
PLN20	12 ÷ 24	0 ÷ Vin	20	60 (4 sec)	10 ÷ 30
PLN40	12 ÷ 24	0 ÷ Vin	40	120 (1 sec)	10 ÷ 30

* L'azionamento riduce la tensione nominale di 1-2 Vcc. Il fenomeno è normale e fisiologico. Se serve ottenere 24 ÷ 12 Vcc in uscita sotto ogni condizione di carico, si suggerisce di sovralimentare di un paio di volt.

** Un timer impone il limite con un andamento temporale iperbolico, cioè quanta più corrente eroga e tanto meno è il tempo per il quale ciò è ammesso, prima che appunto la scheda vada in limitazione. Alla corrente di picco (x 3 volte quella nominale) la scheda funziona per pochi secondi.

* *The drive reduces the rated voltage of 1-2 Vdc. This is normal and physiological. If 24 ÷ 12 VDC output is required under all load conditions, it is advisable to supercharge a couple of volts.*

** *A timer imposes a limit with a temporary hyperbolic performance, which means the more current is requested, the less time is permitted with this current before the drive is limited. When the current reaches its peak (3 times the rated value) the drive will work for a few seconds.*

Dotazioni

Equipment

	PLN20 PLN40
Trimmer di selezione ACCEL, DECEL e LIMITE di CORRENTE / <i>Selection Trimmer ACCEL, DECEL, CURRENT LIMIT</i>	■
2 contatti: marcia avanti e marcia indietro / <i>2 contacts : forward and reverse</i>	■
Riferimento di velocità / <i>Speed setpoint reference</i>	■
3 LEDs di segnalazione / <i>3 LEDs signals</i>	■
Segnale di comando di eventuale freno negativo di stazionamento / <i>Command signal for possible negative electromagnetic brake</i>	■
Predisposizione per montaggio a libro e a zoccolo / <i>Arranged for 2 different ways of mounting</i>	■
Memorizzazione e segnalazione degli allarmi / <i>Memory storage and report of alarm</i>	■
2 ingressi digitali ausiliari / <i>2 auxiliary digital inputs</i>	■#
1 relè segnalazione allarmi / <i>Alarm output relays</i>	■

uno impegnato dal reset / *one comitted by reset*



Per approfondimenti si raccomanda di scaricare il manuale d'uso dal nostro sito www.transtecno.com alla pagina dei prodotti.

Please, download the user manual for more information from our web site www.transtecno.com from the product page.

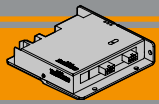

**AZIONAMENTO BIDIREZIONALE PWM PER LA
REGOLAZIONE DI VELOCITA' DEI MOTORI A
CORRENTE CONTINUA A BASSA TENSIONE**

**LOW VOLTAGE BIDIRECTIONAL
PWM DC MOTORS CONTROL**

Dimensioni

Dimensions

PLN20

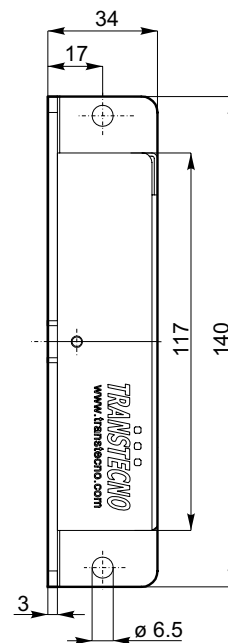
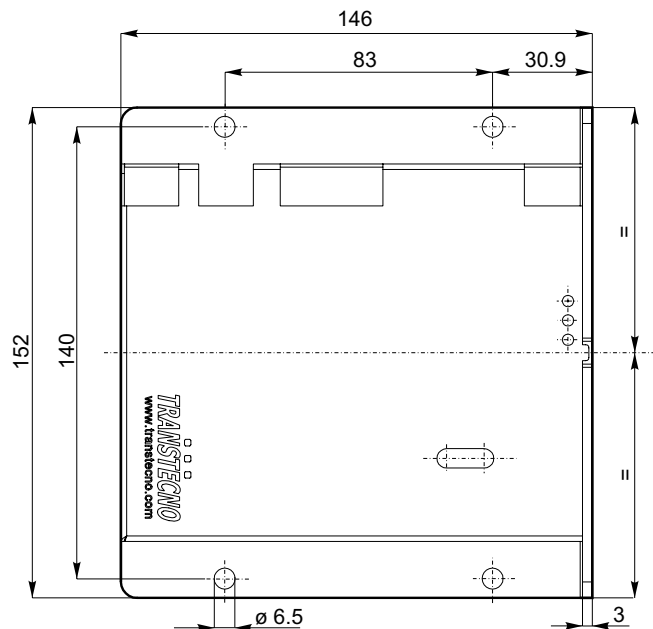

PLN40

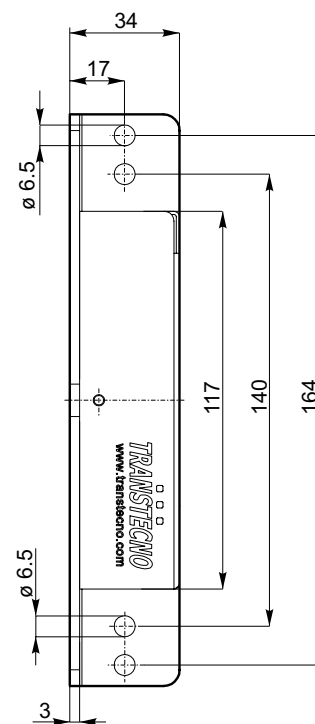
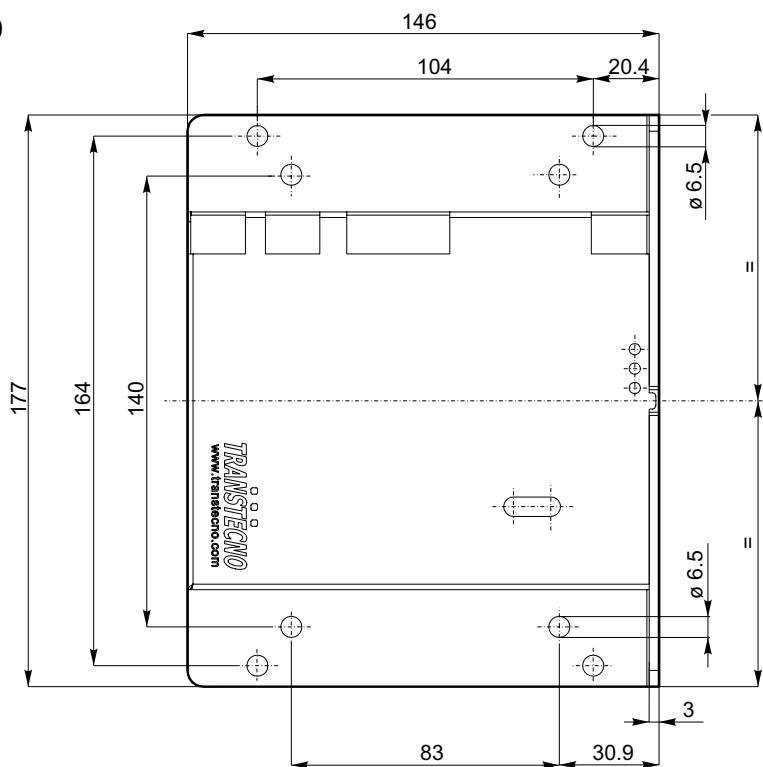

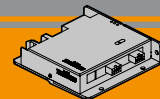

GUIDA alla selezione dell'azionamento

Drive selection GUIDE

Corrente di uso del motore \leq Corrente nominale dell'azionamento

Real motor current \leq Rated current of the drive

Attenzione: la reale corrente assorbita dal motore può essere diversa da quella indicata in targhetta.

PLN19-8 = max 6 A

PLN20 = max 22 A

PLN40 = max 44 A

Vedere sotto la tabella per esemplificazioni

Warning: the real absorbed current by the motor can be different from the one written on the nameplate.

PLN19-8 = max 6 A

PLN20 = max 22 A

PLN40 = max 44 A

See the table below for quick reference

Codice motore Motor code	Corrente motore Motor current S1	Scheda-Drive (servizio motore-motor duty) S1	Corrente motore Motor current S2	Scheda-Drive (servizio motore-motor duty) S2
EC020.120	3.2	PLN19-8 – PLN20	4	PLN19-8 – PLN20
EC020.240	1.5	PLN19-8 – PLN20	2	PLN19-8 - PLN20
EC035.120	5.2	PLN19-8 – PLN20	8	PLN20
EC035.240	2.6	PLN19-8 - PLN20	4	PLN19-8 - PLN20
EC050.120	6.8	PLN20	9.4	PLN20
EC050.240	3.4	PLN19-8 - PLN20	4.7	PLN19-8 - PLN20
EC070.120	8.4	PLN20	11.8	PLN20
EC070.240	4.2	PLN19-8 - PLN20	5.9	PLN19-8 - PLN20
EC100.120	12	PLN20	16.8	PLN20
EC100.240	6	PLN19-8 - PLN20	8.4	PLN20
EC100.24E	6	PLN19-8 - PLN20	8.4	PLN20
ND100.120	13.9	PLN20	19	PLN20
ND100.240	6.9	PLN20	9.0	PLN20
EC180.120	21.5	PLN20	30	PLN40
EC180.240	10.8	PLN20	15	PLN20
EC180.24E	10.8	PLN20	15	PLN20
ND180.120	20	PLN20	30	PLN40
ND180.240	10	PLN20	14	PLN20
EC250.120	30	PLN40	39	PLN40
EC250.240	15	PLN20	19.5	PLN20
EC350.240	21	PLN20	29.4	PLN40
EC350.240BR				
EC600.240	35.5	PLN40	47	PLN40
EC600.240BR				

PLN

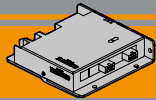

Note/Notes



MA TRANSTECNO S.A.P.I. DE C.V.
 Av. Mundial # 176, Parque Industrial
 JM Apodaca, Nuevo León,
 C.P. 66600
 MÉXICO
 T +52 8113340920
 info@transtecno.com.mx
 www.transtecno.com.mx



TRANSTECNO SRL
 Via Caduti di Sabbiano, 11/D-E
 40011 Anzola dell'Emilia (BO)
 ITALY
 T+39 051 64 25 811
 F +39 051 73 49 43
 sales@transtecno.com
 www.transtecno.com



HANGZHOU TRANSTECNO POWER TRANSMISSIONS CO LTD
 No.4 Xiuyan Road Fengdu Industry Zone
 Pingyao Town Yuhang District
 Hangzhou City, Zhejiang Province
 311115 – CHINA
 T +86 571 86 92 02 60
 F +86 571 86 92 18 10
 info-china@transtecno.com
 www.transtecno.cn



TRANSTECNO U.S.A. LLC
 5440 S.W. 156th Place Miami,
 FL 33185 - USA
 Tel: +1 (305) 220-4423
 Fax: +1 (305) 220-5945
 usaoffice@transtecno.com



TRANSTECNO B.V.
 Ind. terrein Wieken/Vinkenhof
 De Stuwdam,43
 3815 KM Amersfoort - NETHERLANDS
 Tel: +31(0) 33 45 19 505
 Fax: +31(0) 33 45 19 506
 info@transtecno.nl
 www.transtecno.nl



SALES OFFICE INDIA
 A/10, Anagha, S.N. Road, Mulund (W) Mumbai
 400080 - INDIA
 Tel: +91 9820614698
 Fax-Italy: +39 051 73 49 43
 indiaoffice@transtecno.com



SALES OFFICE BRAZIL
 Rua Dr. Freire Alemão 155 / 402 - CEP. 90450-060
 Auxiliadora Porto Alegre RS - BRAZIL
 Tel: +55 51 3251 5447
 Fax: +55 51 3251 5447
 Mobile: +55 51 811 45 962
 braziloffice@transtecno.com
 www.transtecno.com.br



TRANSTECNO AANDRIJFTECHNIEK B.V.
 De Stuwdam 43
 3815 KM Amersfoort - NETHERLANDS
 Tel: +31 (0) 33 20 4 7 006
 info@transtecnoaandrijftechnik.nl
 www.transtecnoaandrijftechnik.nl



SALES OFFICE SOUTH KOREA
 D-304 Songdo BRC Smart Valley 30, Songdomirae-ro,
 Yeonsu-gu, Incheon, 406-840 - KOREA
 Tel: +82 70 8288 2107
 Fax: +82 32 815 2107
 Mobile: +82 10 5094 2107
 koreaoffice@transtecno.com



**TRANSTECNO IBÉRICA
 THE MODULAR GEARMOTOR, S.A.**
 C/Enginy, 2 Nave 6 - 08850 Gavà (Barcelona) - SPAIN
 Tel: +34 931 598 950
 info@transtecno.es
 www.transtecno.es



SALES OFFICE OCEANIA
 44 Northview drive, Sunshine west 3020
 Victoria - AUSTRALIA
 Ph +61 03 9312 4722
 Fax +61 03 9312 4714
 Mobile: +61 0438060997
 oceaniaoffice@transtecno.com
 www.transtecno.com.au



SALES OFFICE FRANCE
 Tel: +33 (0) 6 85 12 09 87
 Fax-Italy: +39 051 73 49 43
 franceoffice@transtecno.com
 www.transtecno.fr

TRANSTECNO[®]
 the modular gearmotor
 www.transtecno.com